

**VPAM**

Vereinigung der  
Prüfstellen für angriffs-  
hemmende Materialien  
und Konstruktionen

Personal Protective Equipment  
**Ballistic Protective Vests**  
- Requirements, Classifications and  
Testing Methods-

**VPAM**  
**BSW 2006**  
Stand: 14.05.2009

## Testing Guideline

### “Ballistic Protective Vests”

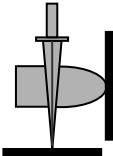
Englische Übersetzung, es gilt immer die deutsche Originalfassung!

English translation, however the original German version always prevails!

**Editor:**

**Vereinigung der Prüfstellen für angriffshemmende Materialien und  
Konstruktionen (VPAM)**

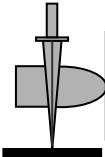
As of: 14 MAY 2009

 <p><b>VPAM</b> Vereinigung der Prüfstellen für angriffs- hemmende Materialien und Konstruktionen</p>	<p>Personal Protective Equipment <b>Ballistic Protective Vests</b> <b>- Requirements, Classifications and Testing Methods-</b></p>	<p><b>VPAM</b> <b>BSW 2006</b> Stand: 14.05.2009</p>
--	--	--

**First publication of VPAM BSW 2006: 13 OCT 2006**

List of Changes

Number	Change Date	Changes were effected under the following numbers

 <p><b>VPAM</b> Vereinigung der Prüfstellen für angriffs- hemmende Materialien und Konstruktionen</p>	<p>Personal Protective Equipment <b>Ballistic Protective Vests</b> <b>- Requirements, Classifications and Testing Methods-</b></p>	<p><b>VPAM</b> <b>BSW 2006</b> Stand: 14.05.2009</p>
--	--	--

## Preface

This guideline was elaborated by the Vereinigung der Prüfstellen für angriffshemmende Materialien und Konstruktionen (VPAM)

VPAM - BSW 2006 can be acquired at:



Geschäftsstelle

**Deutsche Hochschule der Polizei**

**Polizeitechnisches Institut**

**Postfach 48 03 53**

**48080 Münster**

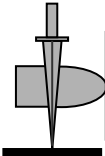
**Deutschland**

Tel.: +49 (0) 25 01 806-259

Fax: +49 (0) 25 01 806-239

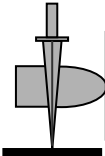
E-mail: [pti@dhpol.de](mailto:pti@dhpol.de)

Internet: [www.vpam.eu](http://www.vpam.eu) oder [www.dhpol.de](http://www.dhpol.de)

 <p><b>VPAM</b> Vereinigung der Prüfstellen für angriffs- hemmende Materialien und Konstruktionen</p>	<p>Personal Protective Equipment <b>Ballistic Protective Vests</b> <b>- Requirements, Classifications and Testing Methods-</b></p>	<p><b>VPAM</b> <b>BSW 2006</b> Stand: 14.05.2009</p>
--	--	--

## Table of Contents


Page

 <b>VPAM</b> Vereinigung der Prüfstellen für angriffs- hemmende Materialien und Konstruktionen	<b>Personal Protective Equipment</b> <b>Ballistic Protective Vests</b> <b>- Requirements, Classifications and</b> <b>Testing Methods-</b>	<b>VPAM</b> <b>BSW 2006</b> Stand: 14.05.2009
---	--	---

## Introduction

The underlying principles of tests and conformity evaluations of materials, constructions and products that offer protection against attacks with firearms are described in the “General Basis for Ballistic Material, Construction and Product Tests”, VPAM - APR 2006.

Moreover, the product specific requirements, classifications and testing procedures for ballistic protective vests are described in this testing guideline.

 <p><b>VPAM</b> Vereinigung der Prüfstellen für angriffshemmende Materialien und Konstruktionen</p>	<p>Personal Protective Equipment <b>Ballistic Protective Vests</b> <b>- Requirements, Classifications and Testing Methods-</b></p>	<p><b>VPAM</b> <b>BSW 2006</b> Stand: 14.05.2009</p>
--	--	--

## 1 Scope of Applicability

Ballistic protective vests are to protect from the effects of projectiles (ballistic protection) from handguns and long guns. They are to prevent not only that the projectile penetrates the vest but also to protect from severe injuries that may be caused to the body by the impulse of the stopped projectile.

A protective vest with textile protective panel may also be worn in conjunction with body armour that gives resistance to stabbing and/or impact.

The body armour may be made up as follows:

- **combined protection**

If an already tested ballistic protective vest is to be worn in conjunction with an already tested stabbing- and/or impact-resistant body armour, the combination is to be submitted to a ballistic test (3 shots at an angle of 90° - in the event of an overlapping model: 3 shots at 25° - without prior conditioning).


- **upgradable protection**

If an already tested ballistic protective vest is to be upgraded with stabbing and/or impact resistance, it is to be submitted to a stabbing and/or impact test as well as a ballistic test (3 shots at an angle of 90° - in the event of an overlapping model 3 shots at 25° - without prior conditioning).

- **integrated protection**

If a body armour offers ballistic protection as well as stab- and/or impact protection at the same time, the non-separable armour carrier is to be subjected to both a ballistic test and a test regarding the stabbing and/or impact resistance.

Should in the course of a test a deficiency that is not covered by the tests of this testing guideline be identified, the examiner is to proceed testing as per this guideline.

	<p>Personal Protective Equipment  <b>Ballistic Protective Vests</b>  <b>- Requirements, Classifications and Testing Methods-</b></p>	<p><b>VPAM</b>  <b>BSW 2006</b>  Stand: 14.05.2009</p>
---	--	--


## 2 Normative References

The following normative documents include definitions that by way of references in this text are an element of this guideline. Dated references do not take into consideration posterior changes or revisions of this publication.

Contract parties applying this guideline are recommended to check the possibility to use the most recent editions of the normative documents given below.

In the event of undated references use the latest edition of the normative document referred to. Legal provisions are always to be used as amended.

- VPAM – APR 2006, Allgemeine Prüfgrundlagen für ballistische Material-, Konstruktions- und Produktprüfungen [General Basis for Ballistic Material, Construction and Product Tests]
- VPAM - KDIW 2004, Prüfrichtlinie "Stich- und Schlagschutz" [Testing Guideline "Stabbing and Impact Resistance"]
- DIN EN 10204, Metallische Erzeugnisse - Arten von Prüfbescheinigungen [Metallic Manufactures – Types of Test Certificates]
- TDCC, Maßblätter der Ständigen Internationalen Kommission für die Prüfung von Handfeuerwaffen (C.I.P.) [Dimension Sheets of the Constant International Commission for the Examination of Hand-held Weapons]

	<p>Personal Protective Equipment  <b>Ballistic Protective Vests</b>  <b>- Requirements, Classifications and Testing Methods-</b></p>	<p><b>VPAM</b>  <b>BSW 2006</b>  Stand: 14.05.2009</p>
---	--	--

### 3 Terms and Definitions

The following definitions are effective for the purpose of this testing guideline:

#### 3.1 Ballistic Protective Equipment

It is to protect from the effects of projectiles (penetration resistance) from handguns and long guns. In this field principally protective vests and accessories, such as throat protectors and groin protectors, are required.

#### 3.2 Ballistic Protective Vest

Usually consists of an armour carrier which contains one or more ballistic panels or plates, providing protection against one or more threat types for the entire torso or a major part thereof. The armour carrier may also contain modular inserts, such as armour plates and/or trauma plate inserts.

#### 3.3 Ballistic Protective Overvest

It is worn on top of the clothes.

#### 3.4 Ballistic Protective Undervest

It is worn concealed underneath the outer clothing. It is adjusted individually to the wearer.

#### 3.5 Size of the Model

The name of the protective vest as given by the manufacturer, indicating the body dimensions and the sex of its respective user.


#### 3.6 Model Name or Code

The name or code denominating a protective vest. Every protective vest of a specific model must be identical in its structure, protection class and minimum protective area. A model may be available in various sizes.

#### 3.7 Test Specimen

A sample conditioned for testing (protective equipment in the smallest available production size or in the dimension of 350 mm by 400 mm).



	<p>Personal Protective Equipment  <b>Ballistic Protective Vests</b>  <b>- Requirements, Classifications and Testing Methods-</b></p>	<p><b>VPAM</b>  <b>BSW 2006</b>  Stand: 14.05.2009</p>
---	--	--

Note: The structure and the materials of the sample must comply with the manufacturer's description or the requirements of the purchaser and meet the customary quality of the product/products. The test specimen must be accompanied with acceptance test certificates (e.g. batch number) and documentation on the exact composition, especially materials used, and production and processing procedures.

### **3.8 Protective Equipment**

Denominates protective clothing, such as torso, throat and groin protectors. They are to protect against injury resulting from attacks.

### **3.9 Protection Area**

Area that is covered (protected) by the protective equipment and that is to be tested.

### **3.10 Protection Class**

Denomination for a classification of the intended protection level, against a specific attack potential.

### **3.11 Protective Vest**


Protective equipment that covers the torso in part or completely.

### **3.12 Trauma**

An injury that is inflicted on the body upon impact by the transfer of kinetic energy, resulting from the stoppage of a projectile by a protective vest. Blunt trauma is measured against a plasticine backstop, as per the indentation depth and volume.

### **3.13 Trauma Panel**

An element of a protective vest that reduces trauma.

	<p>Personal Protective Equipment  <b>Ballistic Protective Vests</b>  <b>- Requirements, Classifications and Testing Methods-</b></p>	<p><b>VPAM</b>  <b>BSW 2006</b>  Stand: 14.05.2009</p>
---	--	--

## 4 Requirements, Classifications and Testing Conditions

### 4.1 General Requirements, Classifications and Testing Conditions

Ballistic protective vests are classified in accordance with the protective classes of VPAM - APR 2006, No 4.1, Table 1.

When protection against stabbing and impact is called for, testing is carried out in accordance with testing guideline VPAM – KDIW 2004.

#### 4.1.1 Requirement “Attached Shot” of Classes 1 to 3

When testing calls for an “Attached Shot”, testing is carried out in accordance with Annex 1 in combination with subsection 6.10.

### 4.2 Allowed Indentation Depth and Volume in Plasticine

The limit of the indentation depth in plasticine is determined by the plasticity of the plasticine, which is to be measured in line with subsection 5.2.1.

From the average value of the plasticity measurement, which amounts to  $20.0 \pm 2.0$  mm plus 22.0 mm (basic constant, resulting from the medically determined limit), the maximum admissible indentation depth is derived.


The residual energy of the projectile transferred to the body must not exceed 70 J. The maximum permitted volume, measured in terms of the average value of the plasticity measurement, is to be determined in line with subsection 6.6 of VPAM – APR 2006.

If so required in the individual case, the limit may be reduced by an amount to be determined by the commissioner or the procurer.

When assessing the permissible indentation depth and the permitted volume in plasticine, the respective average values of a test (e.g. after conditioning at +70 C) are to be applied.

### 4.3 Determining the Ballistic Limit $V_{50}$

The ballistic limit  $V_{50}$  is to be determined in line with method VPAM-KNB of subsection 6.4.3 of VPAM - APR 2006.

	<p>Personal Protective Equipment  <b>Ballistic Protective Vests</b>  <b>- Requirements, Classifications and Testing Methods-</b></p>	<p><b>VPAM</b>  <b>BSW 2006</b>  Stand: 14.05.2009</p>
---	--	--

## 5 Test Set-up and Test Equipment

Sections 5 and 6 of VPAM - APR 2006 govern the test and measuring equipment as well as the test procedures for ballistic protective vests.

It has to be ensured that the parameters laid down in VPAM - APR 2006, subsection 4.1, Table 1 are fulfilled.

### 5.1 Measuring and Targeting Set-up

The measuring and the targeting set-up have to correspond to Annex 1 of this guideline.

### 5.2 Backing Material

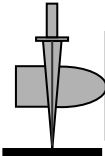
In order to accommodate the test specimen and to determine the indentation depth and volume, plasticine is to be used. The plasticine has to be put into a box with the internal dimensions of 350 mm x 400 mm x 150 mm in such a way that the box is completely filled to the edges and that no gaps are generated. Before testing the box has to be put into storage for 16 hours minimum with a constant temperature ( $\pm 2$  C), which ensures the plasticity of  $20.0 \pm 2.0$  mm. Before the plasticity measurement the plasticine has to be subjected to approx. 30 hits (e.g. with wooden hammer) and, subsequently, the plasticine is to be drawn off with a blade.

#### 5.2.1 Testing of Plasticity


The box with the plasticine is to be placed on a sufficiently stable footing. In order to test the plasticity of the plasticine a ball drop system with a steel ball (diameter  $63.5 \pm 0.05$  mm, mass  $1,039 \pm 5$  g) is to be used. The distance between the lower edge of the ball and the surface of the plasticine is to be  $2,000 \pm 5$  mm. The planar surface or the tangential plane to the surface of the plasticine has to be horizontal at the point of impact of the ball, with an accuracy of  $\pm 5$  mm at 1 m. The ball must be dropped five times onto the plasticine. The centre of a point of impact must be no closer than some 80 mm from any edge of the box and no closer than some 140 mm from the centre of another point of impact. The indentations (depressions) in the plasticine result in a "die-pentagon". Before or after the ball has been dropped, the plasticine has to be drawn off and, subsequently, the indentation depth has to be measured. The resulting depressions are not to be filled up. The lowest point of the indentation of the ball in the plasticine, relative to the surface of the plasticine before the test, has to be measured with a measuring accuracy of  $\pm 0.5$  mm.

The plasticine with its applied conditioning temperature is acceptable when the depth of each depression is  $20.0 \pm 2.0$  mm.

The plasticine has to fulfil the requirements of the indentation geometry during the test period. Prior to sample testing, plasticity has to be measured and from the five

 <p><b>VPAM</b> Vereinigung der Prüfstellen für angriffs- hemmende Materialien und Konstruktionen</p>	<p>Personal Protective Equipment <b>Ballistic Protective Vests</b> <b>- Requirements, Classifications and Testing Methods-</b></p>	<p><b>VPAM</b> <b>BSW 2006</b> Stand: 14.05.2009</p>
--	--	--

measurements the average has to be calculated, which is to be stated in the test report.

	<p>Personal Protective Equipment  <b>Ballistic Protective Vests</b>  <b>- Requirements, Classifications and Testing Methods-</b></p>	<p><b>VPAM</b>  <b>BSW 2006</b>  Stand: 14.05.2009</p>
---	--	--

## 6 Test Procedure

### 6.1 Number of Test Specimens

Of every protective vest to be tested identical test specimens (samples) have to be submitted at the same time. The required number of test specimens is to be found in Annex 2. If diverse requirements are to be tested in combination, the number of test specimens is to be increased accordingly. They are to be tested within a narrow timeframe.

### 6.2 Size of Test Specimens

For the testing of flexible materials (soft ballistics) elements of protective vests of only the smallest intended production size or test specimens of the size 350 mm x 400 mm (tolerance  $\pm 30$  mm) are to be used. Hard armour plates must have a minimum size of 240 mm x 280 mm. All other sizes have to be agreed on with the institute carrying out the testing.

### 6.3 Conditioning of Test Specimens

Prior to the test, for at least 16 hours the test specimens have to be stored away, either in an upright standing or hanging position at  $-20 \pm 2^\circ \text{C}$ , at  $+20 \pm 2^\circ \text{C}$  with  $65 \pm 5\%$  relative humidity, and at  $+70 \pm 2^\circ \text{C}$  each.


### 6.4 Climatisation of Test Specimens with Textile Protective Panel

The test specimen is to be conditioned for at least 16 hours (with a maximum of 24 hours) in a climatized cabinet, either in an upright standing or hanging position at  $+40 \pm 5^\circ \text{C}$  with 90 to 95 % relative humidity.

If the test specimen is fitted with a humidity-resistant outer shell, the shell is to be opened up on one side and the ballistic panel is to be removed. Then the ballistic panel is to be conditioned in the climatized cabinet as per the conditions outlined above. After being stored away the ballistic panel is to be reintroduced into the previously removed humidity-resistant shell.

### 6.5 Testing of Backing Materials

When testing the projectile penetration resistance of a sample, before and after each test the plasticity of the backing material has to be determined as per subsection 5.2.1. The institute carrying out the test has to ensure that the plasticity of the backing material during the test is within the permitted range.

	<p>Personal Protective Equipment  <b>Ballistic Protective Vests</b>  <b>- Requirements, Classifications and Testing Methods-</b></p>	<p><b>VPAM</b>  <b>BSW 2006</b>  Stand: 14.05.2009</p>
---	--	--

## 6.6 Fixing of Test Specimens

The test specimen has to be fixated in a flush manner on the plasticine block in line with Annex 1, Figure 3 (extremely heavy test specimens have to be supported from below, if required). Prefabricated parts or prefabricated combination vests (resistant to projectile penetration and stabbing) have to be backed up with plasticine according to their shape.

## 6.7 Identification of Impact Points

The impact points on the test specimen have to be marked and numbered as per Annex 3 of this guideline. Insert pockets for protective vests, which due to their structure have seam or contact points (e.g. ceramic plates) that are not discernible from the outside, have to be clearly marked by the commissioner.

## 6.8 Positioning of Weapon

The distance between the weapon's muzzle and the test specimen has to be either 5 + 0.5 m or 10 + 0.5 m (see Annex 1).

## 6.9 Angle of Impact

The angles of impact are at  $90^\circ \pm 2^\circ$  ( $0^\circ \pm 2^\circ$  NATO) and  $25^\circ \pm 2^\circ$  ( $65^\circ \pm 2^\circ$  NATO). In the event of the  $25^\circ$  proof firing the box with the backing material and the test object is to be turned around its vertical axis (Annex 1, Figure 3).

Test objects with an overlapping design are to be positioned in such a way that the projectile is given the possibility to enter in between the plates.

In the event that deficiencies should be discerned, the examiner may select also other angles of impact.


## 6.10 Number and Distance of Hits

The number of hits required for testing is to be found in Annex 2.

The location of points of impact and their distances to each other and to the edge are to be found in Annexes 3 to 3.4.

For protective vests of Classes 1 to 3 another hit (edge hit) has to be effected on the unconditioned test object on any location with a distance of  $30 \pm 5$  mm from the outer edge of the ballistic material and at least 75 mm from the corner. The indentation depth and the volume in plasticine do not need to be measured.

If the protective material consists of several plates that touch upon one another, the contact points are to be tested in addition on three different places with an angle of  $90^\circ$ .

	<p>Personal Protective Equipment  <b>Ballistic Protective Vests</b>  <b>- Requirements, Classifications and Testing Methods-</b></p>	<p><b>VPAM</b>  <b>BSW 2006</b>  Stand: 14.05.2009</p>
---	--	--

In the event of overlapping design, the areas of coverage are to be tested in addition on three different places at an angle of 25°.

Optionally, test specimens that are made up of soft textile protective material only may be tested in addition by way of three attached shots. In so doing, the weapon (exterior diameter of the muzzle 15 mm) is to be pressed continuously against the test specimen with a force of  $100 \pm 5$  N. The entire recoiling mass (weapon, mounting system, 10-kilogramme weight, etc.) is to be  $50 \pm 1$  kg (see Annex 1, Figure 4). The angle of firing is 90°. The volume in plasticine does not need to be measured.

### **Testing of Protective Vests for Females**

If protective vests are particularly shaped (e.g. moulded) in the breast area, this area has to be specially tested in addition.

If the “attached shot” is called for, protective vests of Classes 1 to 3 are to be tested with two hits each in the area of transition into the breast moulding and in the breast tip, as per Annex 1, Figure 4.

If the “attached shot” is not called for, protective vests of classes 1 to 3 are to be tested with two hits each in the area of transition into the breast moulding and in the breast tip, as per Annex 1, Figure 4.

The indentation depths in plasticine do not need to be measured.

### **6.11 Conduct of Testing**

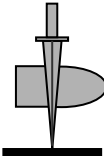
The type of ammunition has to be selected in accordance with the class to be tested, as per VPAM - APR 2006, subsection 4.1, Table 1.

For the testing, a test specimen, conditioned pursuant to subsection 6.3 or climatized pursuant to subsection 6.4, is to be fixed on the backing material. The weapon is to be positioned. The shots have to be fired as per subsection 6.9 and Annex 3. The location and the direction (in the event of designs that touch upon one another or overlap) of a hit have to be selected in such a way that critical areas are tested with sufficient accuracy.

Temperated, cooled and climatized test specimens are to be fired upon in intervals of 2 (Hit 1), 5 (Hit 2) and 8 minutes (Hit 3), with the tolerance being + 15 seconds, respectively, after being taken out of the climatized cabinet. During the time periods, in which the indentation depths in the plasticine are determined, the test specimen may not be taken off (establishment of comparable testing conditions).

It must be ensured that all hits are located more than 100 mm from the interior edges of the plasticine box. If the size of the test specimen (protection area) does not allow for the required number of hits, further comparable test specimens have to be used.

Should in the course of a test a deficiency (e.g. contact points), which is not covered by the tests of this testing guideline, be identified, it is up to the discretion

 <p><b>VPAM</b> Vereinigung der Prüfstellen für angriffs- hemmende Materialien und Konstruktionen</p>	<p>Personal Protective Equipment <b>Ballistic Protective Vests</b> <b>- Requirements, Classifications and Testing Methods-</b></p>	<p><b>VPAM</b> <b>BSW 2006</b> Stand: 14.05.2009</p>
--	--	--

of the institute carrying out the test to proceed testing as per this guideline. If required, further test specimens may have to be used.

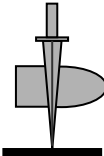
## **6.12 Evaluation of the Test Results**

After every shot the impact has to be evaluated (see subsection 3.3.5 of VPAM - APR 2006). Subsequently, the indentation depth, the diameter and the volume in plasticine (starting from the original surface) have to be measured, the plasticine has to be planed and drawn off with a blade, and the clamped test specimen has to be planed as well.

In the event of hard ballistic materials which remain permanently deformed after a shot, it has to be ensured before the subsequent shot that they fully rest upon the plasticine.

Ricochets, every time the bullet exits the specimen at the side as well as other special incidents are to be documented.

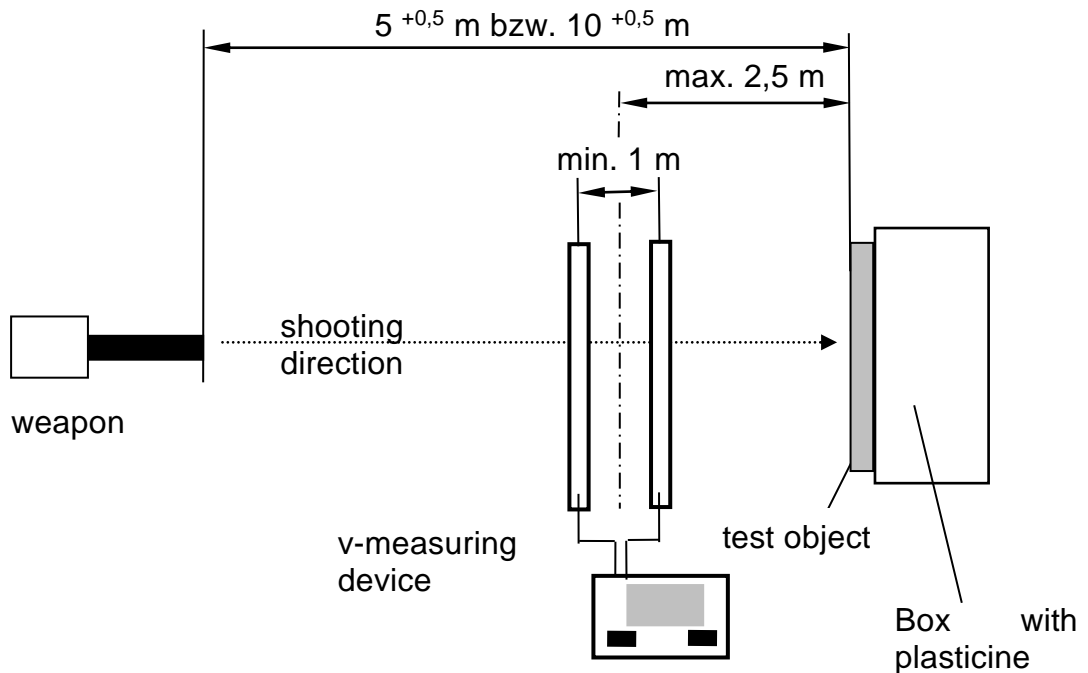


 <p><b>VPAM</b> Vereinigung der Prüfstellen für angriffs- hemmende Materialien und Konstruktionen</p>	<p>Personal Protective Equipment <b>Ballistic Protective Vests</b> <b>- Requirements, Classifications and Testing Methods-</b></p>	<p><b>VPAM</b> <b>BSW 2006</b> Stand: 14.05.2009</p>
--	--	--

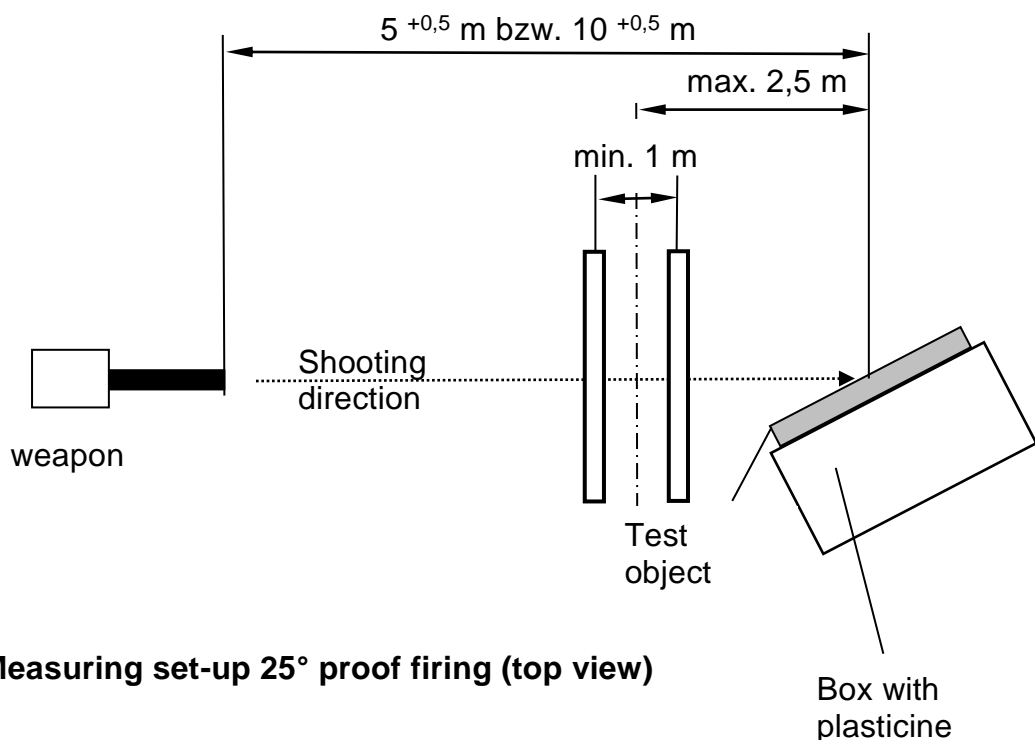
## **7 Evaluation and Documentation of the Test, Test Report**

Evaluation and documentation of the test have to be done as per VPAM - APR 2006, section 7.

**Annex 1: Measuring and Targeting Set-up**

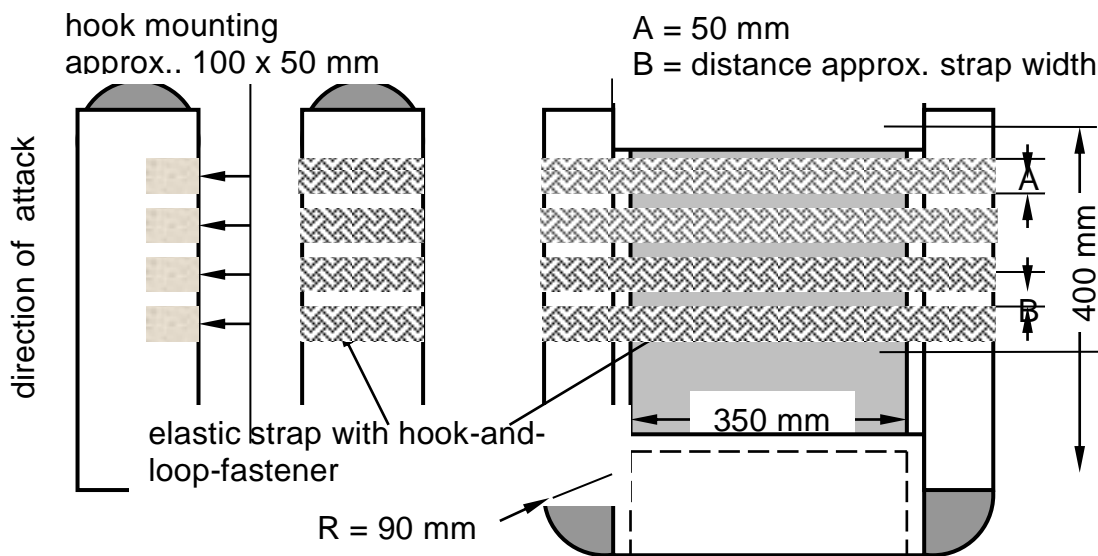


**Figure 1: Measuring set-up 90° proof firing (lateral view)**



**Figure 2: Measuring set-up 25° proof firing (top view)**

Annex 1 (cont'd):



**Figure 3: Box with rounded shoulders**

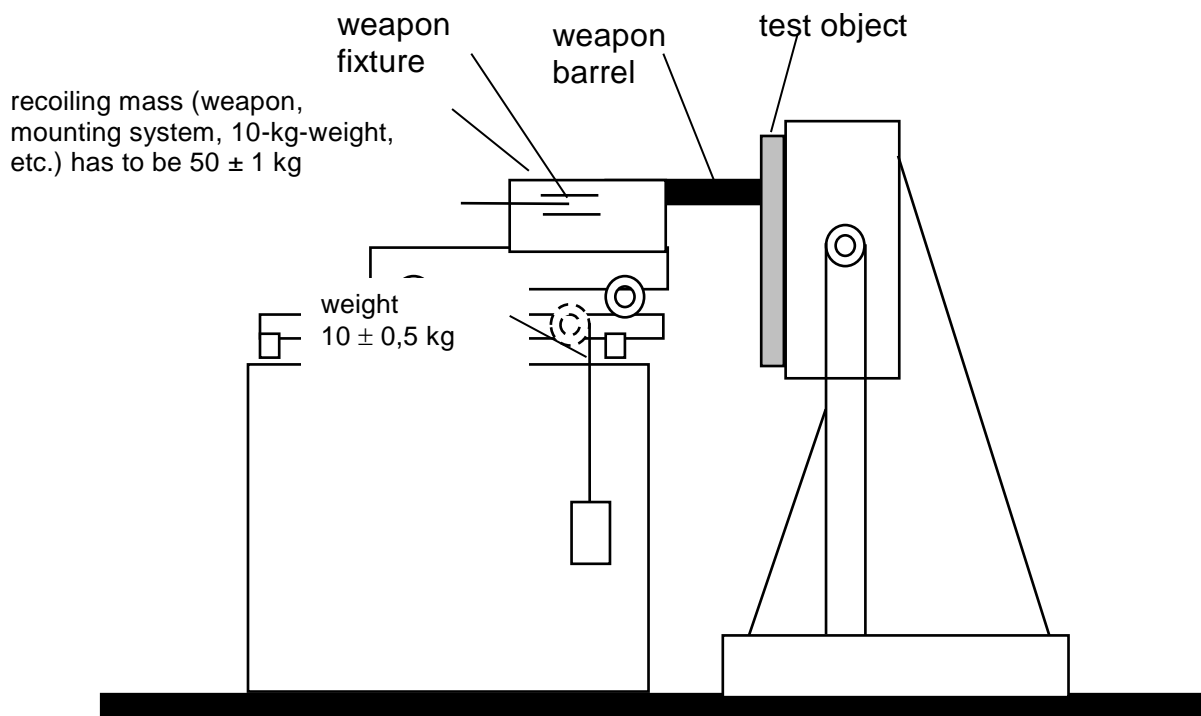
Internal dimensions of the box: 400 mm x 350 mm x 150 mm  
 Rubber band: 700 mm x 50 mm, with a Velcro strap each <sup>1</sup> 100 mm x 50 mm sewn at the end of the band.

Fabric hook-and-loop fastener strap: 100 mm x 50 mm, on every side in the centre 4 fabric hook-and-loop fastener straps attached to the box; mind the distances A and B!

For tests with an angle of impact of 25° the box has to be turned horizontally to the left from the shooting direction. In the event of arched test specimens it must be ensured that, independent of the position of the plasticine block, the angle of impact is 25°.

<sup>1</sup> Source of supply: Velcro ® band, black, 50 mm wide, VELCRO GmbH, Kleines Wegle 1, 71691 Freiberg am Neckar, Germany

**Annex 1 (cont'd):**



**Figure 4: Test set-up for attached shot**

The weapon fixture is mounted on a basis that is mobile horizontally via two pillar guides.

The entire structure is mounted on a mobile lifting table which may be fixated on the ground in the desired position.

The contact pressure of the weapon's barrel is created by a weight with the mass of  $10 \pm 0.5$  kg, which via a deflector roll presses the firing support with the basis onto the test object.

Annex 2: Scope of testing for ballistic protective vests with a smooth design

Test conditions for the test specimen		90° / +20 C	25° / +20 C	Attached/ +20 C  (Optional)	Climate +40 C	/ +70° C	-20° C	Ballistic limit V <sub>50</sub> / +20 C	
Class	Calibre Ammunition								
1	.22 LR	Test object no	1	2	3	4	5	6	7, 8, 9
(9 Test Specimen)	Winchester	Number of hits/dispersio n pattern	3 + 1 / Annex 3.1	3 / Annex 3.2	3 / Annex 3.1	3 / Annex 3.1	3 / Annex 3.1	3 / Annex 3.1	V <sub>50</sub> / Annex 3.3
2	9 mm x 19	Test object no	1	2	3	4	5	6	7, 8, 9
(9 Test Specimen)	DAG, DM 41	Number of hits/dispersio n pattern	3 + 1 / Annex 3.1	3 / Annex 3.2	3 / Annex 3.1	3 / Annex 3.1	3 / Annex 3.1	3 / Annex 3.1	V <sub>50</sub> / Annex 3.3
3	9 mm x 19	Test object no	1	2	3	4	5	6	7, 8, 9
(9 Test Specimen)	DAG, DM 41	Number of hits/dispersio n pattern	3 + 1 / Annex 3.1	3 / Annex 3.2	3 / Annex 3.1	3 / Annex 3.1	3 / Annex 3.1	3 / Annex 3.1	V <sub>50</sub> / Annex 3.3



**Personal Protective Equipment**  
**Ballistic Protective Vests**  
**- Requirements, Classifications and Testing Methods-**

**VPAM**  
**BSW 2006**  
 Stand: 14.05.2009

Test conditions for the test specimen		90° / +20 C	25° / +20 C	Attached/ +20 C  (Optional)	Climate / +40 C	+70° C	-20° C	Ballistic limit V <sub>50</sub> / +20 C
Class	Calibre Ammunition							

4	357 Magnum	Test object no	1	2
(10 Test Specimen)	Geco	Number of hits/dispersio n pattern	3 / Annex 3.4	3 / Annex 3.5
	44 Rem. Mag.	Test object no	6	7
	Speer	Number of hits/dispersio n pattern	3 / Annex 3.4	3 / Annex 3.5

3	4	5
3 / Annex 3.4	3 / Annex 3.4	3 / Annex 3.4
8	9	10
3 / Annex 3.4	3 / Annex 3.4	3 / Annex 3.4

5	357 Magnum	Test object no	1	2
(5 Test Specimen)	DAG Spezial	Number of hits/dispersio n pattern	3 / Annex 3.4	3 / Annex 3.5

3	4	5
3 / Annex 3.4	3 / Annex 3.4	3 / Annex 3.4

6	7.62 x 39	Test object no	1	2
(5 Test Specimen)	PS	Number of hits/dispersio n pattern	3 / Annex 3.4	3 / Annex 3.5

3	4	5
3 / Annex 3.4	3 / Annex 3.4	3 / Annex 3.4



**Personal Protective Equipment**  
**Ballistic Protective Vests**  
**- Requirements, Classifications and Testing Methods-**

**VPAM**  
**BSW 2006**  
 Stand: 14.05.2009

Test conditions for the test specimen		90° / +20 C	25° / +20 C	Attached/ +20 C  (Optional)	Climate +40 C	/ +70° C	-20° C	Ballistic limit V <sub>50</sub> / +20 C
Class	Calibre Ammunition							

7	223 Rem.	Test object no	1	2
(10 Test Specimen)	MEN, SS 109	Number of hits/dispersion pattern	3 / Annex 3.4	3 / Annex 3.5
	308 Win.	Test object no	6	7
	MEN, DM 111	Number of hits/dispersion pattern	3 / Annex 3.4	3 / Annex 3.5
8	7.62 x 39	Test object no	1	2
(5 Test Specimen)	BZ	Number of hits/dispersion pattern	3 / Annex 3.4	3 / Annex 3.5

3	4	5
3 / Annex 3.4	3 / Annex 3.4	3 / Annex 3.4
8	9	10
3 / Annex 3.4	3 / Annex 3.4	3 / Annex 3.4
3	4	5
3 / Annex 3.4	3 / Annex 3.4	3 / Annex 3.4

9	308 Win.	Test object no	1	2
(5 Test Specimen)	FNB, P 80	Number of hits/dispersion pattern	3 / Annex 3.4	3 / Annex 3.5

3	4	5
3 / Annex 3.4	3 / Annex 3.4	3 / Annex 3.4

Anlage 2



Personal Protective Equipment  
**Ballistic Protective Vests**  
 - Requirements, Classifications and Testing Methods -

**VPAM**  
**BSW 2006**  
 Stand: 14.05.2009

Test conditions for the test specimen		90° / +20 C	25° / +20 C	Attached/ +20 C	Climate / +40 C	+70° C	-20° C	Ballistic limit V <sub>50</sub> / +20 C
---------------------------------------	--	-------------	-------------	--------------------	--------------------	--------	--------	--

Class	Calibre Ammunition	(Optional)						
-------	-----------------------	------------	--	--	--	--	--	--

10	7.62 x 54 R	Test object no	1	2
(5 Test Specimen)	B32	Number of hits/dispersion pattern	3 / Annex 3.4	3 / Annex 3.5

3	4	5
3 / Annex 3.4	3 / Annex 3.4	3 / Annex 3.4

11	308 Win.	Test object no	1	2
(5 Test Specimen)	Nammo, AP 8	Number of hits/dispersion pattern	3 / Annex 3.4	3 / Annex 3.5

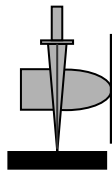
3	4	5
3 / Annex 3.4	3 / Annex 3.4	3 / Annex 3.4

12	308 Win.	Test object no	1	2
(5 Test Specimen)	SWISS P AP	Number of hits/dispersion pattern	3 / Annex 3.4	3 / Annex 3.5

3	4	5
3 / Annex 3.4	3 / Annex 3.4	3 / Annex 3.4

In order to reduce the number of test objects required for the testing of a specific class pursuant to this table, the manufacturer or retailer may decide whether additional shots may be fired on a test object, if possible.





**VPAM**

Vereinigung der  
Prüfstellen für angriffs-  
hemmende Materialien  
und Konstruktionen

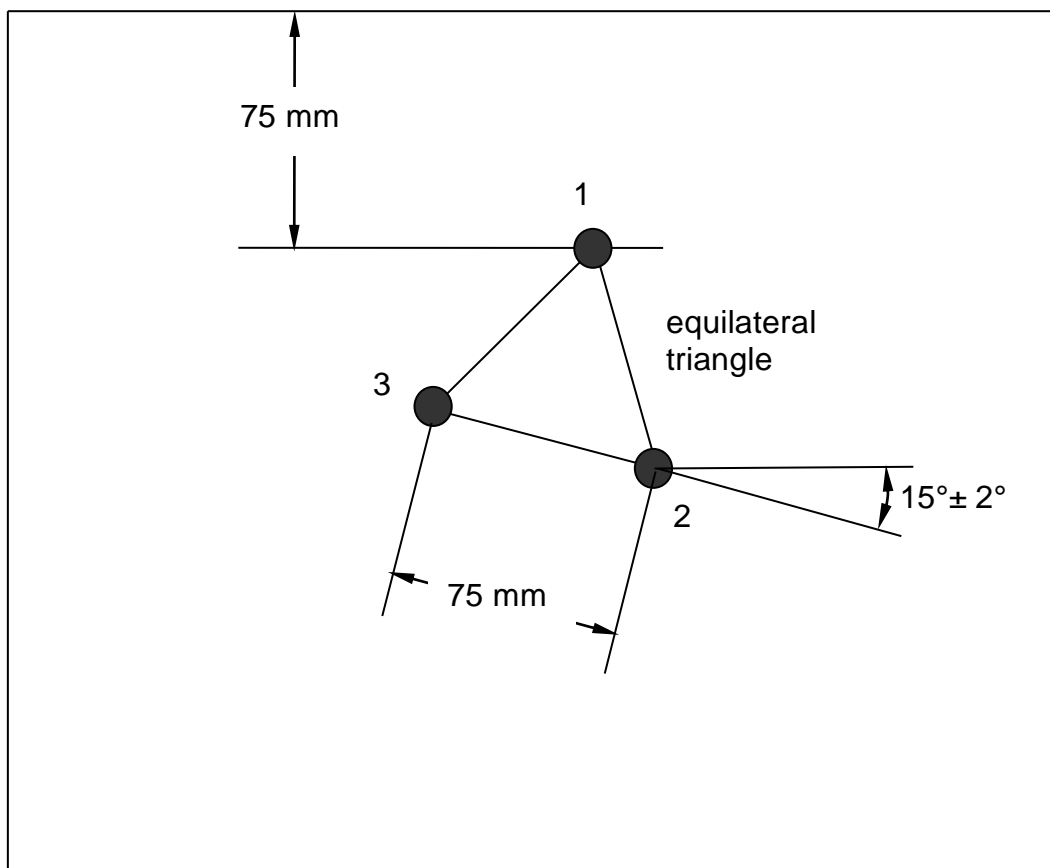
Personal Protective Equipment  
**Ballistic Protective Vests**  
- Requirements, Classifications and  
Testing Methods-

**VPAM**  
**BSW 2006**  
Stand: 14.05.2009

### Annex 3: Presentation of the location of points of impact

#### Annex 3.1: Presentation of the location of points of impact for tests of protective vests with a textile protective panel of Classes 1 to 3 (90° proof firing)

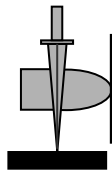
Three impacts each with an angle of impact of 90° (unconditioned test object), climatic test, temperature test (conditioned test objects) and attached shot (optional, Classes 1 to 3).



The shots have to be fired as per the sketch and in the numerical sequence prescribed.

Moreover, the unconditioned test object is to be fired at with another shot (edge hit) on any position with a distance of  $30 \pm 5$  mm from the outer edge of the ballistic material and at least 75 mm from the corner. The indentation depth in plasticine does not need to be measured.

It must be ensured that all hits are located more than 100 mm from the interior edges of the plasticine box.



**VPAM**

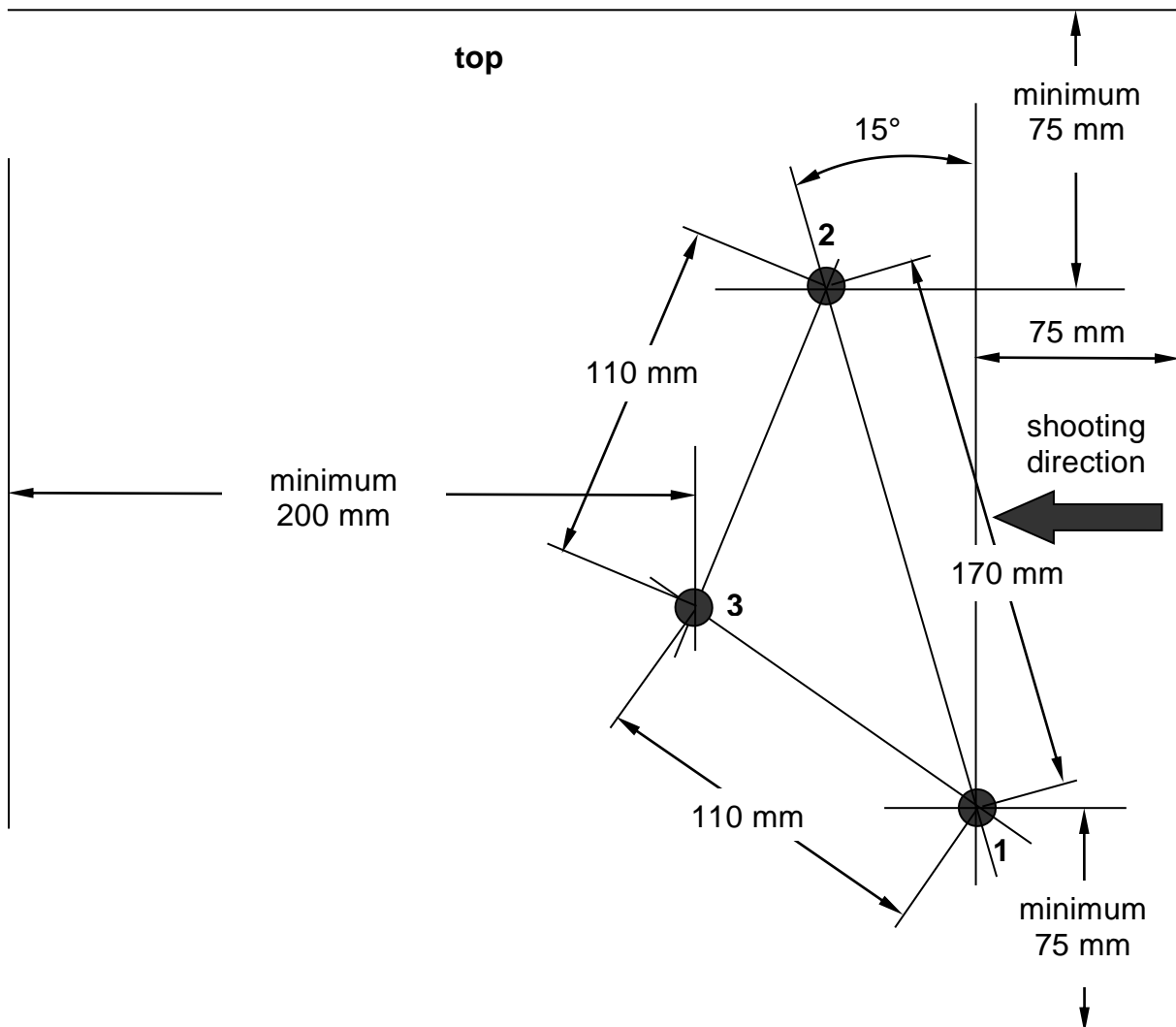
Vereinigung der  
Prüfstellen für angriffs-  
hemmende Materialien  
und Konstruktionen

Schutzausstattungen  
Ballistische Schutzwesten  
- Anforderungen, Klassifizierungen  
und Prüfverfahren -

**VPAM**  
**BSW 2006**  
Stand: 14.05.2009

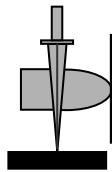
**Annex 3.2: Presentation of the location of points of impact for tests of protective vests with a textile protective panel of Classes 1 to 3 (25° proof firing)**

Three impacts with an angle of impact of 25° each (unconditioned test object, smooth design).



The test specimen is to be turned, if need be, in order to be able to comply with the required minimum distances. The hits have to be delivered as per the sketch and in the numerical sequence prescribed.

It must be ensured that all hits are located more than 100 mm from the interior edges of the plasticine box.



**VPAM**

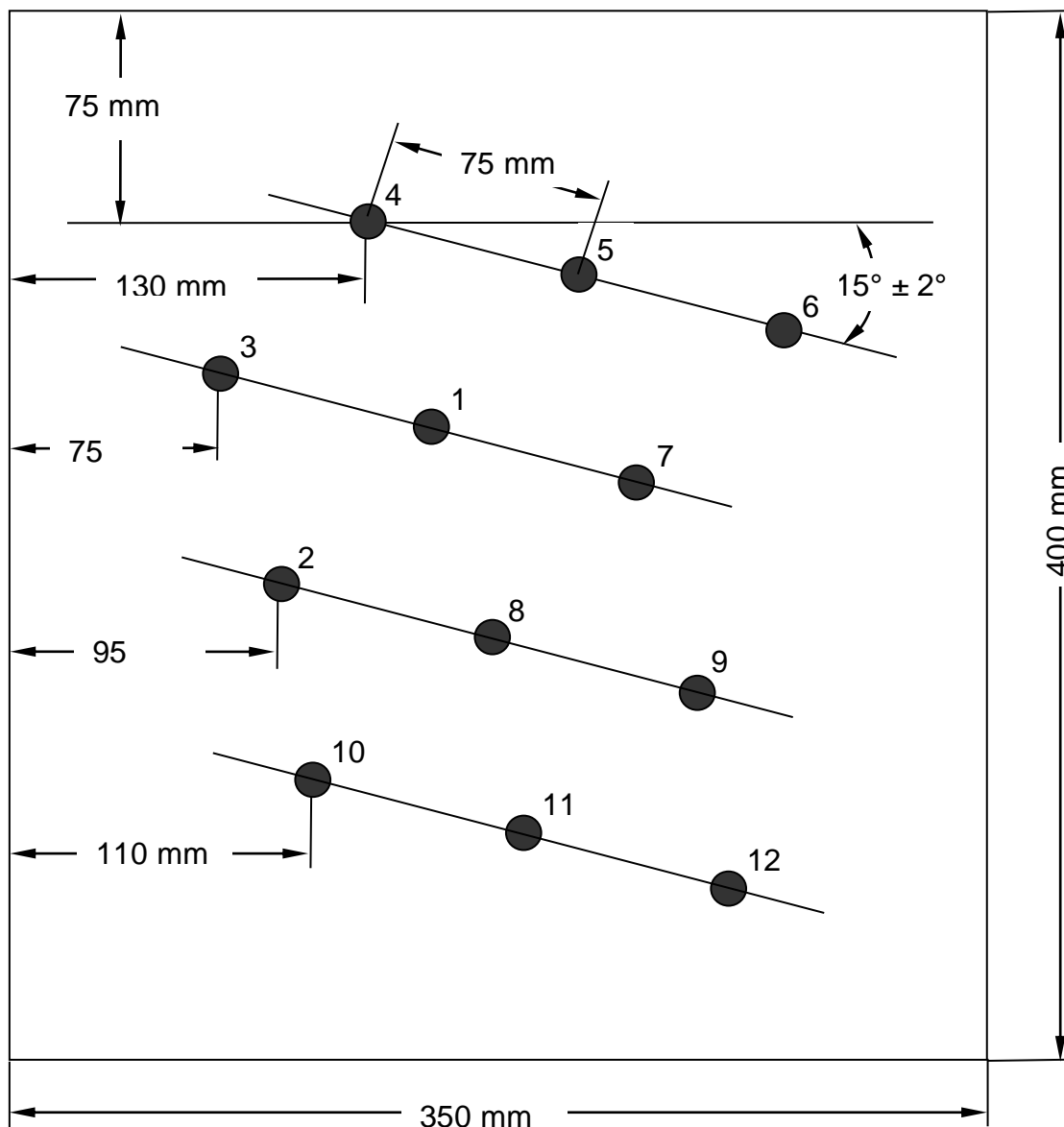
Vereinigung der  
Prüfstellen für angriffs-  
hemmende Materialien  
und Konstruktionen

Schutzausstattungen  
Ballistische Schutzwesten  
- Anforderungen, Klassifizierungen  
und Prüfverfahren -

**VPAM**  
**BSW 2006**  
Stand: 14.05.2009

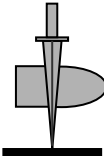
### Annex 3.3: Presentation of the location of points of impact for the calculation of the ballistic limit

The hits will be delivered with an angle of impact of  $90^\circ$  each (unconditioned test object).

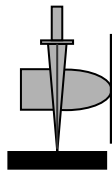


The hits have to be delivered as per the sketch and in the numerical sequence prescribed (distance from one impact to the next: 75 mm minimum).

The impact distances invariably have to be selected in such a way that the effects of the individual hits will not affect each other.

 <p><b>VPAM</b> Vereinigung der Prüfstellen für angriffs- hemmende Materialien und Konstruktionen</p>	<p>Schutzausstattungen <b>Ballistische Schutzwesten</b> <b>- Anforderungen, Klassifizierungen und Prüfverfahren -</b></p>	<p><b>VPAM</b> <b>BSW 2006</b> Stand: 14.05.2009</p>
--	---	--

It must be ensured that all hits are located more than 100 mm from the interior edges of the plasticine box.



**VPAM**

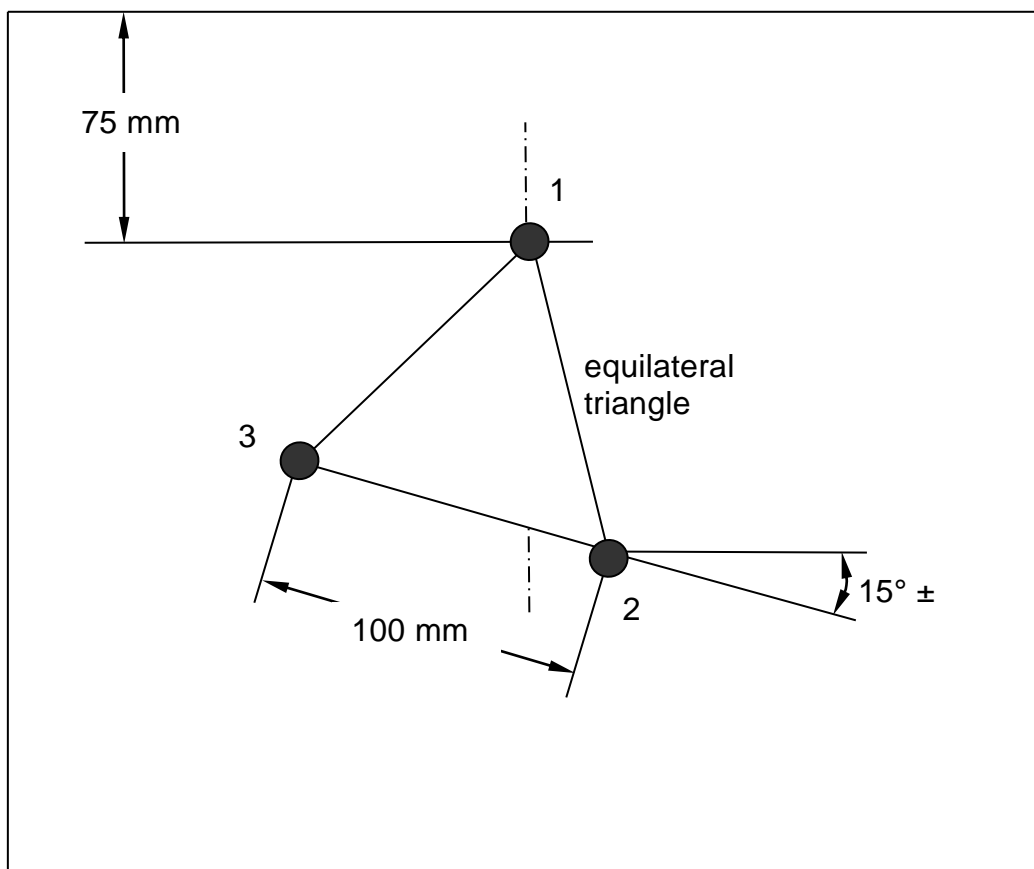
Vereinigung der  
Prüfstellen für angriffs-  
hemmende Materialien  
und Konstruktionen

Schutzausstattungen  
Ballistische Schutzwesten  
- Anforderungen, Klassifizierungen  
und Prüfverfahren -

**VPAM**  
**BSW 2006**  
Stand: 14.05.2009

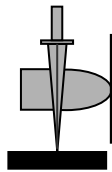
### Annex 3.4: Presentation of the location of points of impact for tests of protective vests with hard armour elements of Classes 4 to 12 (90° proof firing)

Three impacts with an angle of impact of 90° each (unconditioned test object, climatic test, temperature test (conditioned test objects)).



The hits have to be delivered as per the sketch and in the numerical sequence prescribed.

It must be ensured that all hits are located more than 100 mm from the interior edges of the plasticine box.



**VPAM**

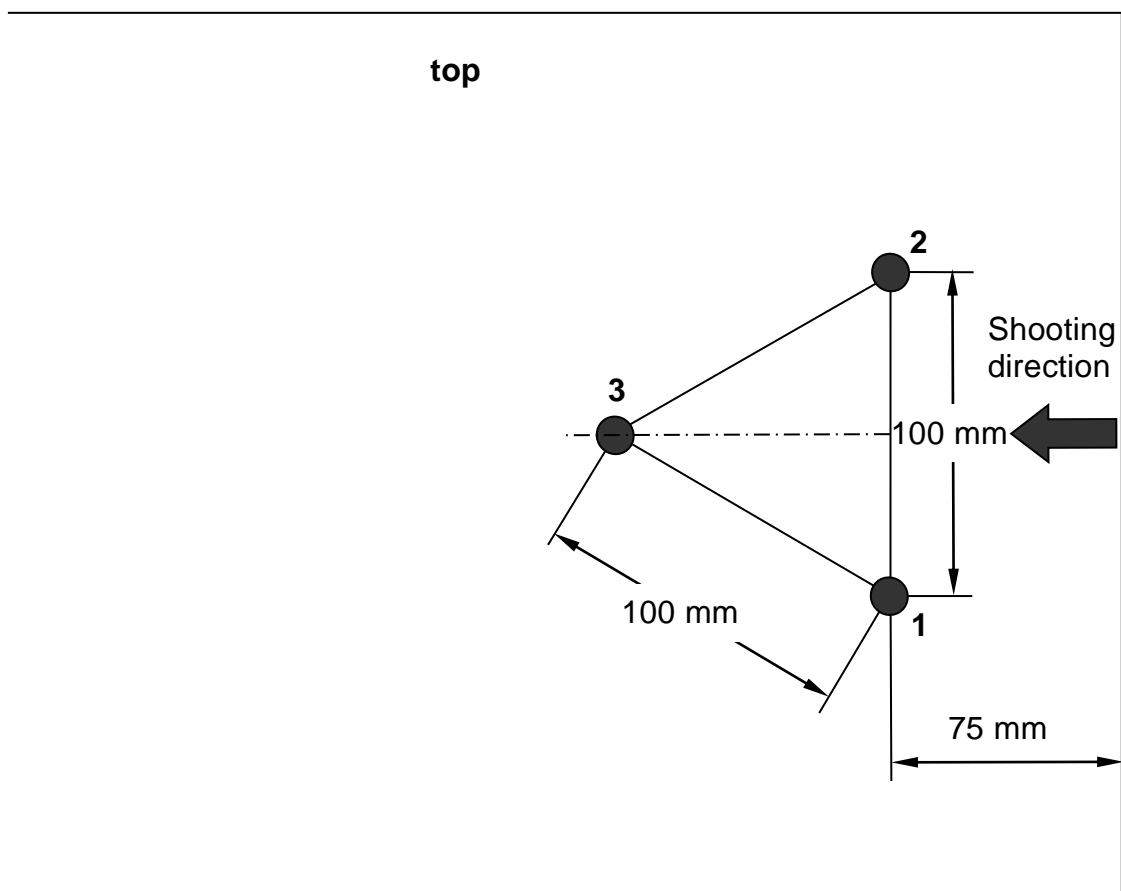
Vereinigung der  
Prüfstellen für angriffs-  
hemmende Materialien  
und Konstruktionen

Schutzausstattungen  
Ballistische Schutzwesten  
- Anforderungen, Klassifizierungen  
und Prüfverfahren -

**VPAM**  
**BSW 2006**  
Stand: 14.05.2009

### Annex 3.5: Presentation of the location of points of impact for tests of protective vests with hard armour elements of Classes 4 to 12 (25° proof firing)

Three impacts with an angle of impact of 25° each (unconditioned test object, smooth design).



The hits have to be delivered as per the sketch and in the numerical sequence prescribed.

It must be ensured that all hits are located more than 100 mm from the interior edges of the plasticine box.